

THE INFORMATION CONTAINED IN THIS DRAWING IS PRIVATE. ANY REPRODUCTION IN PART OR WHOLE WITHOUT WRITTEN PERMISSION IS PROHIBITED.

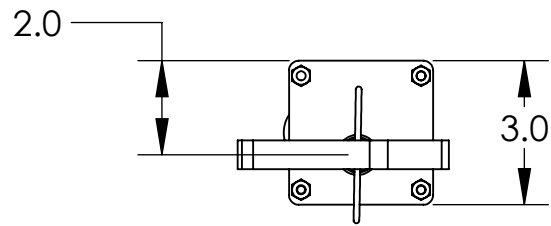
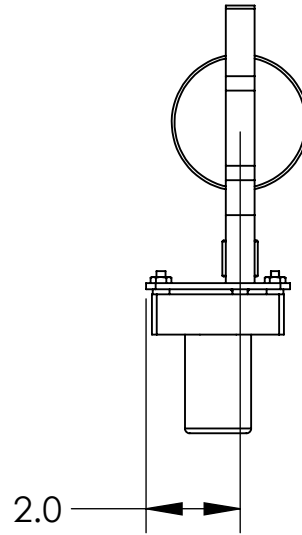
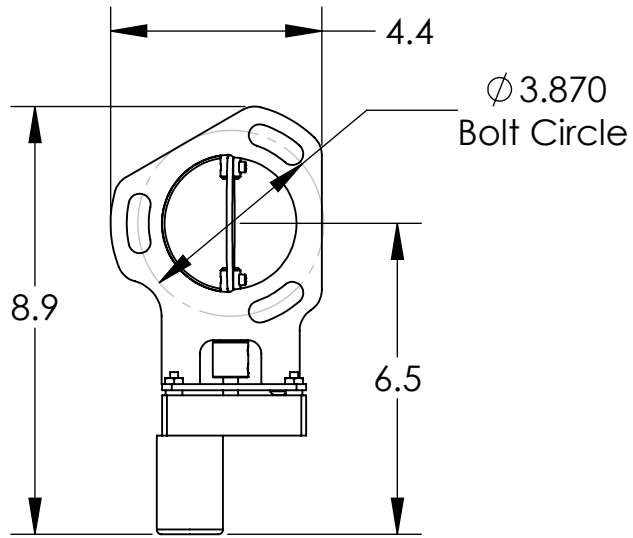

NOTES:
Material

Customer Assembly Drawing
Shown in open position

ALL DIMENSIONS IN INCHES UNLESS SPECIFIED	CAD GENERATED DRAWING, DO NOT MANUALLY UPDATE		Race Ready Performance	
	APPROVALS	DATE	EC300	
TOLERANCES ARE:	DRAWN B. Johnson	9/28/2012	SIZE A	DWG. NO.
	CHECKED		SCALE 1:4	CAD FILE:
				REV. --
				SHEET 2 OF 2